

# Owners Manual

## ENVIROHEAT® Heat Pump Water Heater

Models:

200EH1-14

250EH1-15

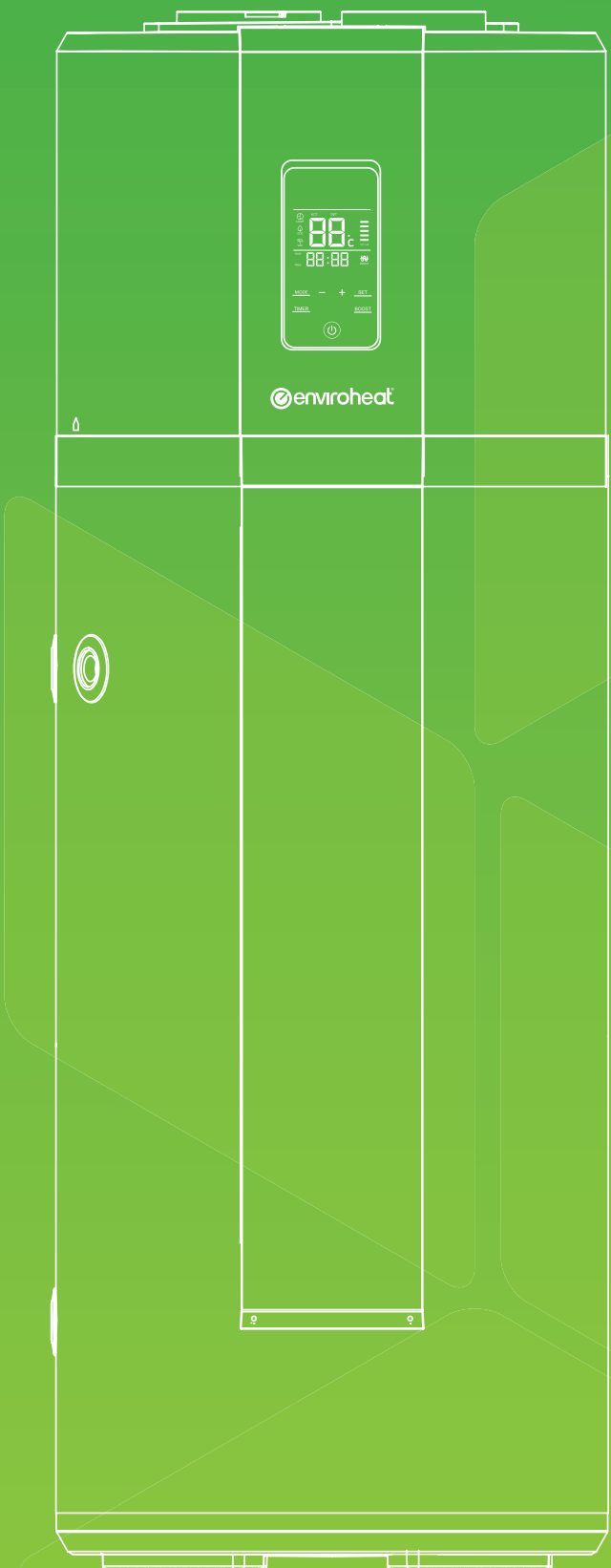

# CONTENTS

<b>IMPORTANT SAFETY INFORMATION</b> .....	<b>3</b>
Interpretation of marks and symbols .....	3
General safety instruction .....	3
Instructions on transportation and storage .....	3
<b>FUNCTIONING &amp; PRINCIPLE OF OPERATION</b> .....	<b>4</b>
<b>SPECIFICATIONS</b> .....	<b>5</b>
Overall Dimensions .....	6
<b>INSTALLATION INTRODUCTION</b> .....	<b>7</b>
Precautions .....	7
Installation Dimensions .....	8
Local Standards .....	9
Safety .....	9
Water Quality .....	9
Supplementary Heat Sources .....	9
<b>PLUMBING CONNECTIONS</b> .....	<b>10</b>
Piping Materials .....	10
Pressure Reducing Valve .....	10
Pressure & Temperature Relief Valve .....	10
Cold Water Expansion Relief Valve .....	10
Important Safety Information .....	10
<b>ELECTRICAL CONNECTIONS</b> .....	<b>11</b>
Electrical Protection Precautions .....	11
<b>COMMISSIONING CHECK LIST</b> .....	<b>11</b>
<b>OPERATION AND FUNCTIONS</b> .....	<b>12</b>
Display .....	12
Screen lock function .....	13
Emergency mode .....	13
How to set the timer .....	13
Recommended system settings .....	13
<b>TROUBLESHOOTING</b> .....	<b>14</b>
Hot water use higher than anticipated .....	14
Water discharge through the pressure relief valve .....	14
<b>MAINTENANCE</b> .....	<b>15</b>
Draining and flushing the system .....	15
Relief valves .....	15
Anode replacement .....	15
Condensate discharge pipe .....	15
<b>CONTACT DETAILS</b> .....	<b>16</b>
<b>STANDARD WARRANTY</b> .....	<b>17</b>
Warranty Terms .....	17
Warranty Conditions .....	17
Warranty Exclusions .....	19
OH&S Disclaimer .....	19
<b>INSTALLATION RECORD</b> .....	<b>20</b>

# IMPORTANT SAFETY INFORMATION

## Interpretation of marks and symbols



Information provided with this warning mark relates to activities that are definitely forbidden or dangerous. Failure to adhere to the instructions may result in damage to the product or users may risk personal danger or injury.



Instructions with this warning mark shall be strictly followed during operation. They relate to the safety of users and the product.



Instructions with this mark relate to important installation requirements that ensure the correct operation of the device.

## General safety instruction

The water heater shall be installed in strict accordance with local wiring regulations and equipped with a power supply containing a ground/earth conductor.

This water heater is not intended for use by young children, infirm persons, or persons lacking relevant skill or experience, without suitable supervision.

Children should be supervised to ensure they do not play with hot water taps or the water heater.



The unit must be installed by a licensed trade person and in accordance with:

- This Installation & Maintenance Guide
- AS/NZS 3500.4 - "National Plumbing and Drainage Code Hot Water Supply Systems-Acceptable Solutions"
- AS/NZS 3000 - Wiring Rules
- Local authority regulations
- Building Codes of Australia
- Local Occupational Health and Safety (OH&S) Regulations

Do not operate this water heater without the electrical thermostat and over temperature cut-out in the circuit.

This appliance contains fluorinated greenhouse gases: R134a / 0.9kg. Fluorinated greenhouse gases are contained in hermetically sealed equipment. Global Warming Potential 100 years (GWP100): 1 430



Personally inspecting or servicing any part of the system is not recommended.

The water heater shall not be installed at places where water drainage is unavailable or impossible.

## Instructions on transportation and storage

During transportation or storage, the heat pump water heater shall be packed in the undamaged package to avoid damage to appearance and performance of the product.



During transportation or storage, the heat pump water heater shall be in the upright position.

Under special conditions, this product may be laid down for a short time/distance as per indication on the side of the package case. The heat pump water heater, after being laid down, shall be kept in an upright position for more than 4 hours before starting up.



This symbol on the product or on its packaging indicates that this product is not to be treated as regular household waste. Instead, it must be taken to a recycling point for electrical equipment. By properly disposing of this product, you are contributing to the preservation of the environment and the wellbeing of your fellow citizens.

Improper disposal is hazardous to your health and the environment. You can obtain further information on how to recycle this product from your municipality, your waste management service or the Enviroheat dealer where you purchased the appliance.

## FUNCTIONING & PRINCIPLE OF OPERATION

Your Enviroheat system is called a heat pump because it collects heat from the ambient air and “pumps” it into the water in the storage vessel. This is done in much the same way that an air conditioner removes heat from a room and expels it to the outside air. A refrigerant is used to transfer the heat via a compressor to a heat exchanger wrapped around the storage tank. As the refrigerant delivers its heat to the water, it cools and condenses, and then passes through an expansion valve where the pressure is reduced, and the cycle starts over. This process, called the Rankine Cycle, has been used for over a century for refrigeration and air conditioning applications and has been used for energy efficient water heating for decades.

### HOW IT WORKS

To understand the concept of heat pumps, imagine a refrigerator **working in reverse.**

While a refrigerator removes heat from an enclosed box and expels that heat to the surrounding air, a heat pump takes the heat from surrounding air and transfers it to water in an enclosed tank.

Heat pump technology makes efficient use of the heat in the surrounding air, even at temperatures as low as  $-7^{\circ}\text{C}$ . In fact the Enviroheat system is so efficient that it can convert 1kW of electricity into over 4kW of heat.



## SPECIFICATIONS

Model	200EH1-14	250EH1-15
Tank volume	195L	195L
Rated voltage/ frequency	220V~240V/50Hz	220V~240V/50Hz
Tank rated pressure	0.7MPa	0.7MPa
Corrosion protection	Magnesium rod	Magnesium rod
Insulation Protection Rating	IPX4	IPX4
Type of system	Monobloc air source heat pump	
COP@7 °C	3.04	3.04
COP@15 °C	3.39	3.41
Tapping cycle	L	L
Auxiliary heating element	1500W	1500W
Rated power input by heat pump	495W	495W
Maximum power input by heat pump	865W	865W
Maximum power input	2365W	2365W
Standby power input/ Pes	35W	35W
Heating up time (7°C)	5.50h	7.35h
Heating up time (15°C)	4.68h	6.17h
Default temperature setting	55°C	55°C
Temperature setting range - with heater	35°C – 75°C	35°C – 75°C
Max working pressure of refrigerant	0.8/2.8MPa	0.8/2.8MPa
Refrigerant type / weight	R134a/0.9kg	R134a/0.9kg
Sound power level	57dB	58dB
STC Zone	Zone 1 – 4	Zone 1 – 5
Ambient temp. operating range of heat pump	-7 – 45°C <sup>*1</sup>	-7 – 45°C <sup>*1</sup>
Water inlet and outlet connection	G3/4" F	G3/4" F
Safety valve connection	G3/4" F	G3/4" F
Drain & Water inlet connection	G3/4" F	G3/4" F
Product Dimensions (mm)	600x629x1692	600x629x1987
Packing dimension without pallet (mm)	736x695x1810	736x695x2120
Packing dimension with pallet (mm)	736x695x1940	736x695x2250
Net/Gross weight	91/103kg	102/115kg

\*1 If the operating ambient temperature is outside of the specified range, the system will use the auxiliary electric heating element to avoid damage to the heat pump.

## Overall Dimensions

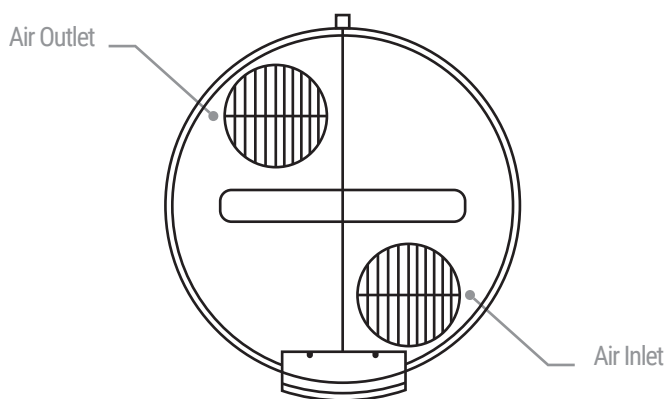
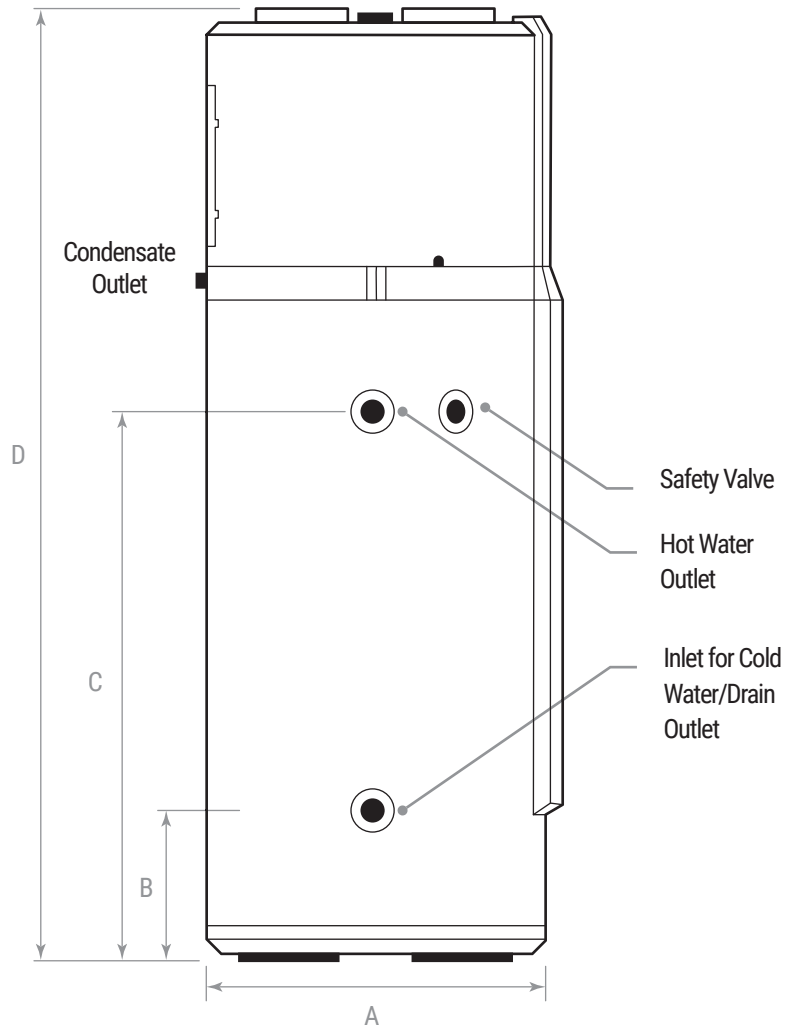
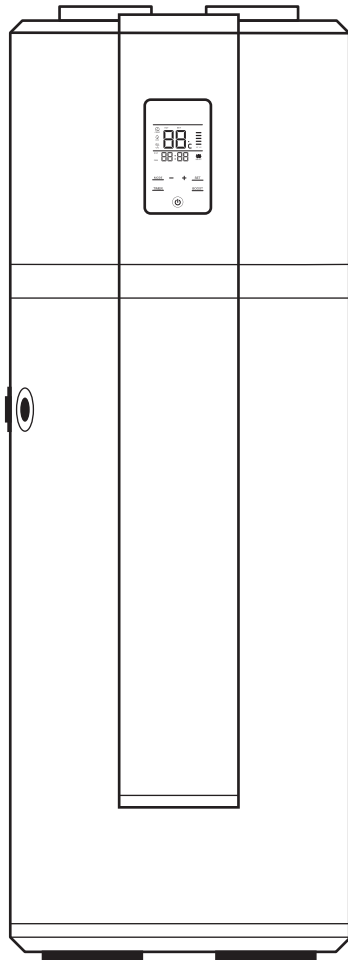

Model	A	B	C	D
<b>200EH1-14</b>	629	270	980	1,692
<b>250EH1-15</b>	629	270	1275	1,987

# INSTALLATION INTRODUCTION

## Precautions



- Do not install the water heater in a position where it will be exposed to gas, vapours or dust.
- Install the appliance on a flat, solid surface. The surface must support the machine weight and the condensate water can be drained freely.
- Ensure that noise due to the operation and air flow of the heat pump complies with the relevant regulations.
- Ensure that there is adequate ventilation around the water heater, do not install in an enclosed space.
- Ensure that there is sufficient space around the unit to allow for service and maintenance.
- Ensure that there is no strong magnetic interference present that may affect control systems.
- Ensure that there are no corrosive gases or liquids present near the unit.
- Where ambient temperatures are likely to drop below 0°C ensure that adequate freeze protection is provided



CAUTION

Keep an adequate distance between the water heater and bedrooms.

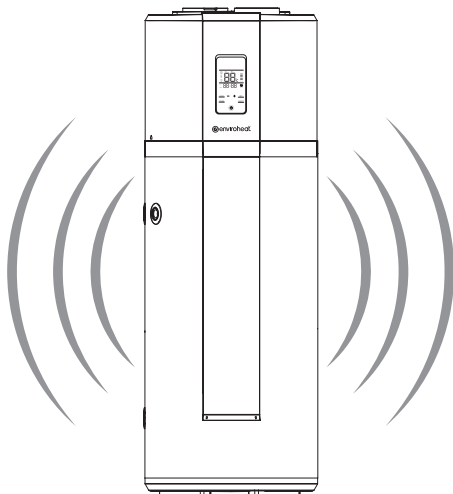

Your Enviroheat system emits very low noise level however there are certain times of the day where any noise may be objectionable. This is especially the case if the system is located near a bedroom and is running while the occupants are sleeping. It is highly recommended that the system be programmed to run when noise is not objectionable, for example between 5am and 9pm, or that the system be located away from bedrooms

## Installation Dimensions

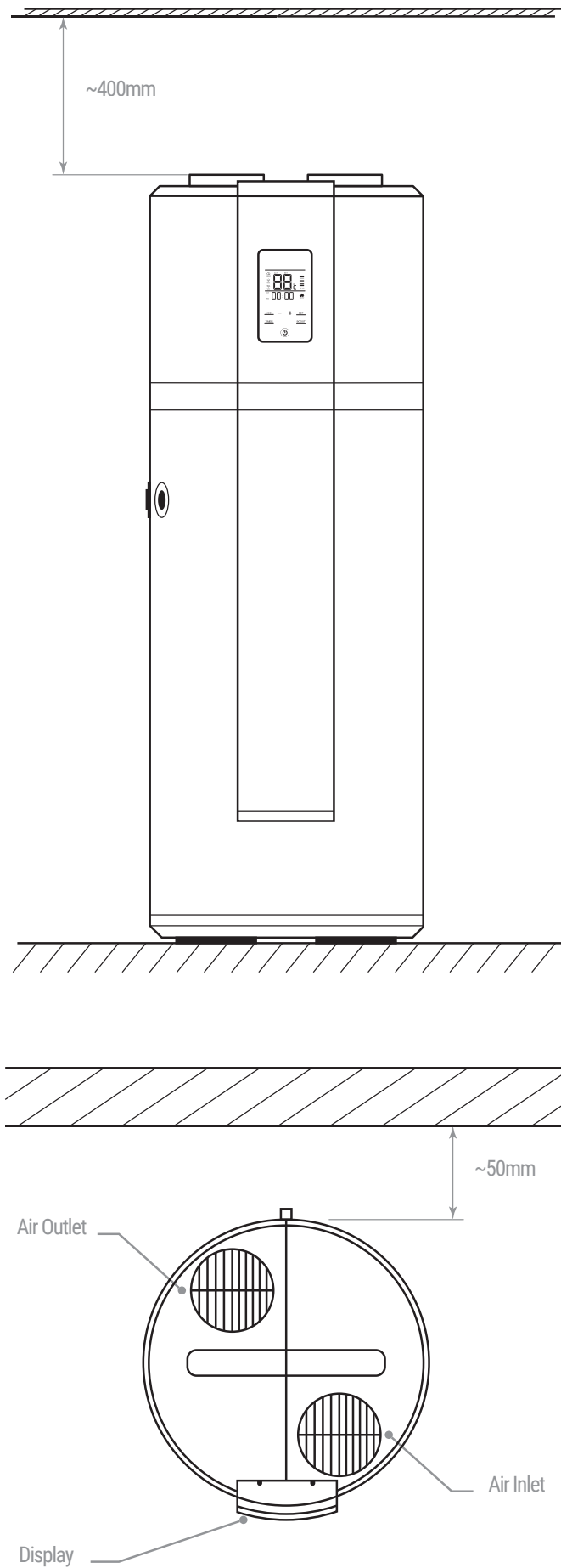



## Local Standards

The following standards and regulations must be taken into account when planning the installation of the Enviroheat water heater system.

- AS/NZS 3500.4.2 Notational plumbing and drainage code hot water supply systems – acceptable solutions.
- HB 263-2004 heated water systems plumbing industry commission.
- AS/NZS 3000 Electrical installations (known as the Australian/New Zealand Wiring Rules).
- Any local regulations that govern this type of installation.
- In frost prone areas

Where these instructions and any local regulations are in conflict, the local regulations shall prevail.

## Safety

Do not commence any aspect of this installation until you have satisfied yourself that all safety issues have been addressed.



**This installation should only be performed by an approved professional with suitable experience and licenses, authorised by Southern Cross Water Heating Pty Ltd Group Australia Pty Ltd to conduct the work.**

It is imperative that installers adhere to Occupational Health and Safety Guidelines at all times. The installer is responsible for their safety and the safety of those around them.

## Water Quality

Water supply from an unfiltered water source that may be highly conductive or have a high mineral content may void the system warranty.

Therefore, to ensure water quality guidelines are met, the following characteristics should not be exceeded.

Water Properties	Acceptable Levels
Total hardness	200 mg/litre or ppm
Total Dissolved Solids (TDS)	600 mg/litre or ppm
Chloride	250 mg/litre or ppm
Magnesium	10 mg/litre or ppm
Sodium	150 mg/litre or ppm
pH	Min 6.5 to Max 8.5
Electrical conductivity	850 µS/cm

In areas of poor water quality, it is recommended that a softener, conditioner or similar device be fitted to the water supply.



**A breach of this condition may void the warranty in the event of damage caused by water quality exceeding these characteristics.**

## Supplementary Heat Sources

If a supplementary heat source is connected to the storage tank, the maximum energy input cannot be more than 10 kW, including the electrical element. Where greater input is required, a pressure and temperature relief valve with a higher kW rating is to be fitted to the storage tank.

Where stove coils are used for supplementary heating the water must be connected in an open vented manner. Refer to Australian Standard AS3500 for more details on acceptable connection solutions.

## PLUMBING CONNECTIONS

### Piping Materials



CAUTION

Southern Cross Water Heating Pty Ltd. recommends the use of copper pipe, certified to AS1432 Class C, for use in the inlet and outlet lines to the heat pump water system.

Plastic piping is not to be used for any portion of the water heater system plumbing unless the pipe manufacturer has rated it for temperatures up to 99°C and a minimum water pressure of 600kPa at these temperatures.

Before making the final connections, rinse the inlet pipes in order not to introduce metal or other particles into the tank.



The inlet water temperature is suggested to be between 10 - 30°C.

Outdoor water pipes and valves should be properly insulated.

### Pressure Reducing Valve

Where the mains water supply pressure is likely to exceed 550 kPa at any time, a 500kPa pressure reducing valve that complies with AS1357 must be fitted to the inlet of the hot water system. This is essential to safeguard the appliance and ensure correct operation.



WARNING

**A breach of this requirement may void the warranty in the event of damage caused by excessive pressure.**

### Pressure & Temperature Relief Valve

Remember this valve can discharge very hot water, so carefully consider its location.

Never discharge onto a solid surface like concrete.



CAUTION



1. Fit the 700 kPa/99°C (10 kW) pressure & temperature relief valve supplied in the parts box into G<sup>3</sup>/<sub>4</sub>"F tank socket;
2. Ensure that the drain line from the pressure and temperature relief has a continuous downslope and falls away from the valve and towards the ground level to a safe location, terminating above the ground level. Please ensure that the drain is installed in a place where it cannot be affected by freezing conditions (per AS3500).

### Cold Water Expansion Relief Valve

Fit the 600 kPa pressure relief valve in the cold water supply pipe after the check valve, stop cock and (if required) pressure limiting valve.

### Important Safety Information

All water heaters have the ability to produce hot water very quickly. To reduce the risk of scald injury it is recommended that a temperature control valve be fitted to the hot water supply pipe work. This valve should be checked every 6 months to ensure its operation and settings remain correct.

Check that the pressure and temperature relief valve drain pipe is not located where it can cause damage if hot water is discharged.



WARNING

**This water heater is not intended for use by young children, infirm persons, or persons lacking relevant skill or experience, without suitable supervision.**

**Children should be supervised to ensure they do not play with hot water taps or the water heater.**

If the hot water system is not used for two weeks or more, a quantity of hydrogen gas, which is highly flammable, may accumulate in the water heater. To dissipate this gas safely, it is recommended that a hot tap be turned on for several minutes at a sink, basin or bath but not a dishwasher, clothes washer, or other appliance. During this procedure there must be no smoking, open flame or any other electrical appliance operating nearby. If hydrogen is discharged through the tap, it will probably make an unusual noise as with air escaping. **Do not place hands or any part of your body beneath the tap during this procedure.**

# ELECTRICAL CONNECTIONS

## Electrical Protection Precautions

For safe performance this water heater is fitted with a thermostat and an over temperature cut-out. **These devices should not be tampered with or removed.**



CAUTION

Do not operate this water heater without the electrical thermostat and over temperature cut-out in the circuit.

Electrical connection of water heaters should be performed by a qualified person in accordance with AS3000 including any current revisions.

## COMMISSIONING CHECK LIST

### System Location – ensure that

- The location where the base of the water heater is located is sufficiently compact to avoid subsidence when the system is filled with water.
- Enough room has been allowed for service and maintenance of the water heater.
- The system has been installed in a location that allows enough ventilation.
- The location is free from any corrosive materials or chemicals.
- The location is free from any excessive dust or material that can become airborne.

### Water System Piping

- Temperature and pressure relief valve (PTR) is properly installed with a discharge pipe plumbed to suitable drain.
- Check that all plumbing connections including piping, valves and fittings are properly installed and free of leaks.
- The system is completely filled with water and all air is drained from the tank and piping.
- The tempering valve has been installed per manufacturer's instructions and the output water temperature is in the range required by local authorities.
- The condensate drain line is installed and plumbed to suitable drain.
- All hot water lines are appropriately insulated and protected from UV degradation.

### Electrical Connections

- The water heater is connected to a supply that has a voltage between 220-240 VAC.
- All hard wiring complies with all local applicable codes and the requirements of this guide.
- The water heater and electrical supply are properly grounded.
- A correctly sized overload protection device has been installed.

# OPERATION AND FUNCTIONS

## Display

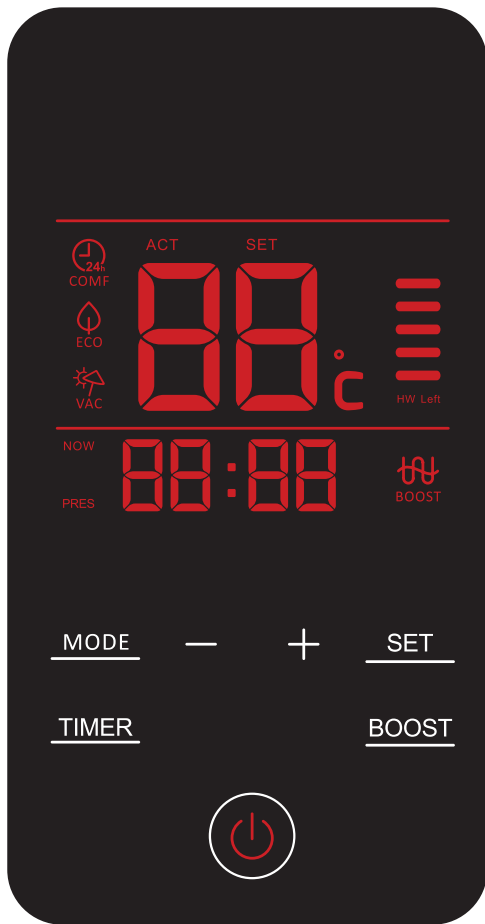

Symbol	Description
	Power ON/OFF switch.
<u>MODE</u>	Working mode selection.
<u>SET</u>	Used to set timer functions and to confirm changes to settings.
<u>TIMER</u>	Sets the time of day. Press the TIMER button to set hours and again to set minutes. The system will automatically revert to run mode after 10 seconds of inactivity. Note: time is in 24 hour mode.
<u>BOOST</u>	<b>Boost mode</b> Heat pump and auxiliary power are activated at the same time. This will auto reset to heat pump only once the SET temperature is achieved. This is useful if a large hot water draw is expected.
	<b>Auto mode</b> Optimised management of the heat pump for maximum hot water delivery. Unit will run on demand. Please note that noise may be objectionable overnight.
	<b>ECO (Off-Peak) mode (recommended setting)</b> In this mode, the unit will run during programmed periods for example between 5am and 9pm. This mode is essential if you have solar power installed in order to maximize free energy utilization. See section on recommended settings.
	<b>Holiday mode</b> If you are planning to be on holiday, you can set your system to turn on the day before you are due to return. Select this mode and use the +/- keys to enter the number of days that you will be away. The system will turn on at midnight on the last day of your holiday to ensure hot water upon your return.
	<b>Anti-legionella</b> To sanitise your stored water against Legionella, the system will automatically turn on once every 7 days and raise the temperature to 65°C.
	This display gives you an indication of how much hot water capacity is available in your system.

## Screen lock function

To avoid unintended changes to the control system, there is a screen lock function that may have been activated during installation and commissioning. This function allows the display of temperature however disables the input keys. The normal operation of the system is not affected in this mode.

To enable or disable this function, press the Timer and Boost function at the same time for 6 seconds at which time the buzzer will sound twice indicating that the function is enabled/disabled.

## Emergency mode

If there is a component failure where the heat pump system faults and will not automatically reset, this function will prioritize the electrical heating system to ensure continuity of hot water supply. If this is necessary, you should contact your Enviroheat Dealer or call the number in the rear of this manual to request service to rectify the fault.

In the period between identifying the fault and a technician attending, the Emergency Mode will ensure hot water supply.

If the system has failed, the buzzer will sound 3 times and a fault code will be displayed. Take note of the fault code so you can advise our service staff. Press the BOOST button for 10 seconds to enable Emergency Mode. The system will now operate with normal temperature control and safety functions until the fault can be rectified by trained staff.

Please note that there are no user serviceable parts inside the system housing and no attempt should be made to repair the system without prior approval. Removal of the top casing may present danger and will void warranty.

## How to set the timer

**Step 1:** Press the TIMER button and use the +/- to set the time of day hours. Press the TIMER button again button the time of day minutes. After 10 seconds, the screen will revert to RUN mode.

**Step 2:** With the unit on, press the MODE button to select ECO mode.

**Step 3:** Press SET to select L1 timer START time. Use the +/- to set the start time hours. Press SET and use the +/- to set the start time minutes.

**Step 4:** Press SET to select L1 timer STOP time. Use the +/- to set the stop time hours. Press SET and use the +/- to set the stop time minutes. After 10 seconds, the system will automatically revert to RUN mode.

Note: There is an additional timer setting, L2, which enables a second timed period. This is generally not required.

You have now set the START and STOP time and time of day. Whilst in ECO mode, the system will only run between the programmed times. Whilst the running noise level of the Enviroheat system is quite low, it is not advisable to allow the unit to run during the night when ambient noise levels are low. If solar power is installed on the property, the settings below will maximise the use of free energy.

## Recommended system settings



### No Solar Power Installed

Small family  
Large family

🕒 START 06:00

🕒 STOP 19:00

🌡️ Temperature 55°C

🕒 START 05:00

🕒 STOP 21:00

🌡️ Temperature 60°C



### Solar Power Installed

Small family  
Large family

🕒 START 07:00

🕒 STOP 18:00

🌡️ Temperature 60°C

🕒 START 06:00

🕒 STOP 18:00

🌡️ Temperature 65°C

## TROUBLESHOOTING

If there is not enough hot water we recommend that the following points are considered as part of the service call. The most obvious reasons for a lack of hot water could be one of the following.

### **Hot water use higher than anticipated**

Often the hot water usage of showers, washing machines and dishwashers is underestimated by the customer. Review these appliances to determine if the daily usage is greater than the storage volume of the water heater. Depending on the model of your system, your tank contains a volume of either 200 or 250L of hot water. If the demand exceeds the stored volume, there may be periods where the water temperature is slightly lower than normal. It is also advisable to inspect hot water tap washers etc. for leakage and replace if necessary.

### **Water discharge through the pressure relief valve**

All Enviroheat heat pump water heaters have two pressure valves located within the system configuration. The cold water expansion control valve (ECV), located in the cold water supply pipe, may release a small amount of water from time to time during the heating cycle of the system. The water discharge is water expanding due to the heating process. Normally the discharge will be less than 10 litres per day. The pressure & temperature valve, located on the storage tank, may also release a small expansion discharge.

It is normal for the Expansion Control Valve (ECV) to drip water when heating. If there is a discharge of more than 10 litres per day from any of the systems valves, it indicates there may be a problem with the valve or an increased water supply as soon as possible.

## MAINTENANCE

The Enviroheat heat pump water heater is designed so that there is little to do in the way of regular system maintenance.



WARNING

**Personally inspecting or servicing any part of the system is not recommended.  
Shut down the machine and cut off the power before any work commences.  
Maintenance operations are important to guarantee optimum performance and extend the life of the appliance.**

### Draining and flushing the system



CAUTION

The system must be completely drained of water before any plumbing work is commenced. This will prevent damage to the storage tank in the event of a vacuum or excessive pressure forming at the storage tank.



The Enviroheat heat pump hot water system should be drained and flushed every five years during a major service of the unit.

1. Turn off and isolate the power supply to the electrical element.
2. Turn off the water supply to the water heater.
3. Release excess pressure from the tank by manually opening the pressure & temperature relief valve.
4. Disconnect the cold water supply pipe connection to the tank.
5. Fit a ½" flexible drain pipe to the cold connection at the tank. Place the open end of the drain hose in a location where it is safe for the hot water to drain away from the tank.
6. Manually open the pressure & temperature relief valve which will allow air into the tank and the water within the tank will flow out via the flexible drain pipe fitted to the cold inlet connection. Hold the valve open until the tank is empty.

### Relief valves



The lever on the relief valves should be operated at least every six months. Failure to do so may result in failure of the tank. If water does not discharge freely from the valves they should be checked and possibly replaced. The relief valves and relief valve drain lines must not be blocked. Some water may discharge during each heating cycle.

Every five years all safety valves should be replaced to ensure the continued life and operational safety of the system. In locations where the potable water has a Total Dissolved Solids (TDS) of greater than 600ppm it is recommended to replace all safety valves every three years.

### Anode replacement



The high quality vitreous enamel lined, low carbon steel tank has two sacrificial anodes for long tank life. These anodes should be inspected every few years and replaced when they have worn out. As a minimum it is recommended that the anodes be changed every five years.

### Condensate discharge pipe



Check the pipe regularly for cleanliness. Any obstruction may cause poor condensate flow or cause the accumulation of water in the heat pump plastic base.

## CONTACT DETAILS

For further information, please call one of the following phone numbers from anywhere in Australia:

### **Consolidated Energy**

For after sales service: 1300 560 944

For sales or new product: 1300 560 944  
info@consolidatedenergy.com.au  
www.enviroheatpump.com

### **Head Office**

Consolidated Energy  
11 Cressall Road  
Balcatta WA 6021



# STANDARD WARRANTY

## Warranty Terms

This warranty is given by Southern Cross Water Heating Pty Ltd in relation to Enviroheat Heat Pump Hot Water Systems (the Product).

The benefits conferred by this warranty are in addition to all other legal rights and remedies of the Customer in respect of the Product. Given installation and application is in accordance with the manufacturer's specifications and instructions, the Product and components are warranted by Enviroheat for the cost of labour and components in the event of defects arising from faulty materials and/or workmanship in accordance with the warranty conditions and exclusions stated in this document.

Where the Product is installed outside the boundaries of a Capital City Metropolitan area or where the Product is installed outside a 25km radius of a Enviroheat Dealer business address, the cost of transport, insurance and travelling will be charged to the consumer.

For all new Product purchases through public sales auctions, internet and/or other electronic sales auctions or remote offerings, the warranty for the Product is the responsibility of the dealer or reseller of the Product, and not of Enviroheat.

Warranty of the Product will remain with the Product for the warranty coverage period.

## Warranty Conditions

***The initial point of contact for all Warranty claims is the Enviroheat Dealer from whom the Product was purchased.***

All warranty claims must be reported to Enviroheat no later than 14 days from the date the fault is reported to the Enviroheat Dealer. All terms of this warranty are effective from the date of installation of the Product and the attending service person reserves the right to verify this date by requesting a copy of the certificate of compliance<sup>1</sup>, installation record issued by an appropriately qualified installer or proof of purchase prior to the commencement of any warranty work.

The Product must have been installed, commissioned, serviced, repaired and removed by a licensed gasfitter or plumber in accordance with the manufacturer's installation instructions, current AS/NZS 3000, AS/NZS 3500, AS/NZS 5601, local regulations and municipal building codes by persons authorised by local regulations to do so. Cost of labour or materials to remedy an installation that does not comply with these requirements will be at the express cost of the installer.

The Product must be operated and maintained in accordance with Enviroheat's operating instructions. This warranty only applies to the Product as supplied by Enviroheat and does not apply to any additional electrical and/or plumbing parts supplied by the installer. Where the appliance has not been sited in accordance the installation instructions or installed such that normal service access is difficult, a service charge may apply. If, at the discretion of the attending service person, access with is assessed as dangerous, service will be refused.

Any work required to gain reasonable access to the appliance will be chargeable to the customer by the attending service person including, but not limited to, removal of cupboards, doors, walls, or the use of special equipment to move components to floor level.

The Product is covered for the indicated period from the date of installation. Should a part of the complete Product be replaced during this period, only the balance of the original warranty will continue to remain effective.

This warranty applies to the Product when it is connected directly to a reticulated water supply from a state approved water utility.

**This warranty does not apply if the Product is connected to any alternative water supplies if the water chemistry and impurity levels of alternative water supplies exceed the limits specified in the Water Properties Table on page 19.**

Examples of alternative water supplies include private bore water, water from private dams and water supplied from a reticulated water supply but where the water chemistry is deliberately altered before supplying the water heater. Should the Product be installed in a regional location where regular flushing is required due to sediment build-up, the drain cock for flushing must be fitted at the time of installation at customer expense. A warranty will apply to rain water tanks, as alternative water supply, ONLY in circumstances where rain water is filtered and free of any physical or sediment debris and water quality does not exceed the limits specified in the Water Properties Table on page 19.

Component manufacturers are at liberty to alter the design or construction of the components notwithstanding that the Product may have been sold by description or sample, even though alterations made have been introduced from the date of contract and the date of delivery provided that the Products are of the same or similar quality and are fit for the purposes for which they are purchased. Such alterations shall not constitute a defect in design or construction under this warranty.

Enviroheat reserves the right to alter the design or construction of the Product within allowance of the relevant Standard(s), industrial and State and Territory legislation without notice. Enviroheat warrants to the original purchaser, or for Product purchased from a Reseller, to the original end user, that the Product will be free from any defects in materials and workmanship from the date of shipment or invoice or, if longer, the period stated in this policy in accordance with the warranty terms in Table 2.

During the warranty period, Enviroheat will at its option apply one of the three following remedies:

- i. provide replacement parts necessary to repair the Product,
- ii. replace the Product with same Product or similar approved newer design,
- iii. refund the amount purchaser paid, LESS DEPRECIATION, upon its return.

Enviroheat or an Enviroheat Dealer will provide labour to resolve warranty issues during the warranty period. Repair service shall be available at the purchaser's location. Enviroheat will determine how and where repair services are provided, and the purchaser may, at Enviroheat's reasonable cost, be required to deliver product to an authorised location.

Replacement parts and/or Products will be new or serviceably used, comparable in function and performance to the original part or Product and warranted for the remainder of the original warranty period. Purchasing additional Products from Enviroheat does not extend your warranty period.

If Enviroheat requires the return of defective parts/Products, the Enviroheat Dealer/purchaser shall return them within 14 days of receiving replacement parts. Failure to return defective parts will attract charges for replaced parts/system and their shipment to the Enviroheat Dealer/purchaser.

Enviroheat offers the following Warranty Terms on all models:

Component	Warranty Coverage	
	Parts Warranty	Labour Warranty
Tank Cylinder	5 year	1 year
Compressor	5 year	1 year
Electrical element	1 year	1 year
Sacrificial anode, PTR valve, ECV	1 year	1 year
Installer supplied valves and fittings	N/A	N/A

## Warranty Exclusions

The following exclusions may cause the warranty to become void, and may incur a service charge and cost of parts that may be required.

1. Accidental damage, failure due to misuse, abuse and accidents.
2. Failure due to incorrect installation and/or attempts to repair the Product other than by an Enviroheat Dealer or approved service personnel.
3. Failure to install, commission, service, repair and remove the Product in accordance with the manufacturer's installation instructions, current AS/NZS 3000, AS/NZS 3500, AS/NZS 5601, local regulations and municipal building codes by persons authorised to do so.
4. Failure due to use of parts other than Enviroheat branded/approved parts.
5. Where the tank or piping system leaks or fails to operate normally due to frost or freezing.
6. Where the Product component has failed directly or indirectly as a result of excessive water pressure, negative pressure (partial vacuum), corrosive atmosphere, faulty plumbing and/or electrical wiring, or major variations in electrical energy supply.
7. Where the water stored in the cylinder exceeds at any time levels as detailed in this document.
8. Any serial tags/stickers on any of the components are removed or defaced.
9. The Product is relocated from its original point of installation.
10. This warranty does not cover:
  - a. claim for damage to walls, foundations, gardens, etc. or any other consequential loss or inconvenience either directly or indirectly due to leakage from the water heating system or any other matter related to the system or its operation.
  - b. the effects of sludge/sediment as a result of connection to a water supply from suitably filtered or treated sources e.g. spring, dam, bore or river.
11. Consequential damage or any incident caused by a breach of the requirements as set out in this document.
12. Our goods come with guarantees that cannot be excluded under the Australian Consumer Law. You are entitled to a replacement or refund for a major failure
13. and for compensation for any other reasonably foreseeable loss or damage. You are also entitled to have the goods repaired or replaced if the goods fail to be of acceptable quality and the failure does not amount to a major failure.

## OH&S Disclaimer

Enviroheat and its Authorised Dealers work with and recommend various installation and plumbing companies to install, test and certify correct operation of solar hot water systems or the Product. Enviroheat is a supplier of systems only.

Each installation must be covered by the installer's insurances, commercial terms and conditions and by the applicable OH&S legislation. Each person that installs assembles or services must comply with all OH&S requirements relevant to the type of work being conducted including, but not limited to, plumbing work, work on heights exceeding 2.5m and electrical work.

The customer must ensure that it complies with all its OH&S obligations. This warranty will be void if these conditions are not met.

# INSTALLATION RECORD

Please complete this page as a record of the installation details for your reference to determine when the system is due for service or if a warranty matter should arise. Return the blue copy of this Installation record to the address below and the pink copy to the Dealer/Installer.

**Consolidated Energy**  
**ABN 85 124 564 361**  
**11 Cressall Road**  
**Balcatta WA 6021**



.....  
Owners Name

.....  
Installation Address

.....  
Suburb

.....  
State

.....  
Telephone (Home)

.....  
(Work)

.....  
Email

..... / ..... / .....  
Date

.....  
System Model Number

.....  
Tank Serial Number

.....  
Installers Name

.....  
Installers Address

.....  
Installers Telephone

.....  
Comments

.....  
Customer Signature

.....  
Installer Signature

..... / ..... / .....  
Date